

Model 140-B™ ENGINE CLEANER 6530-0000-1

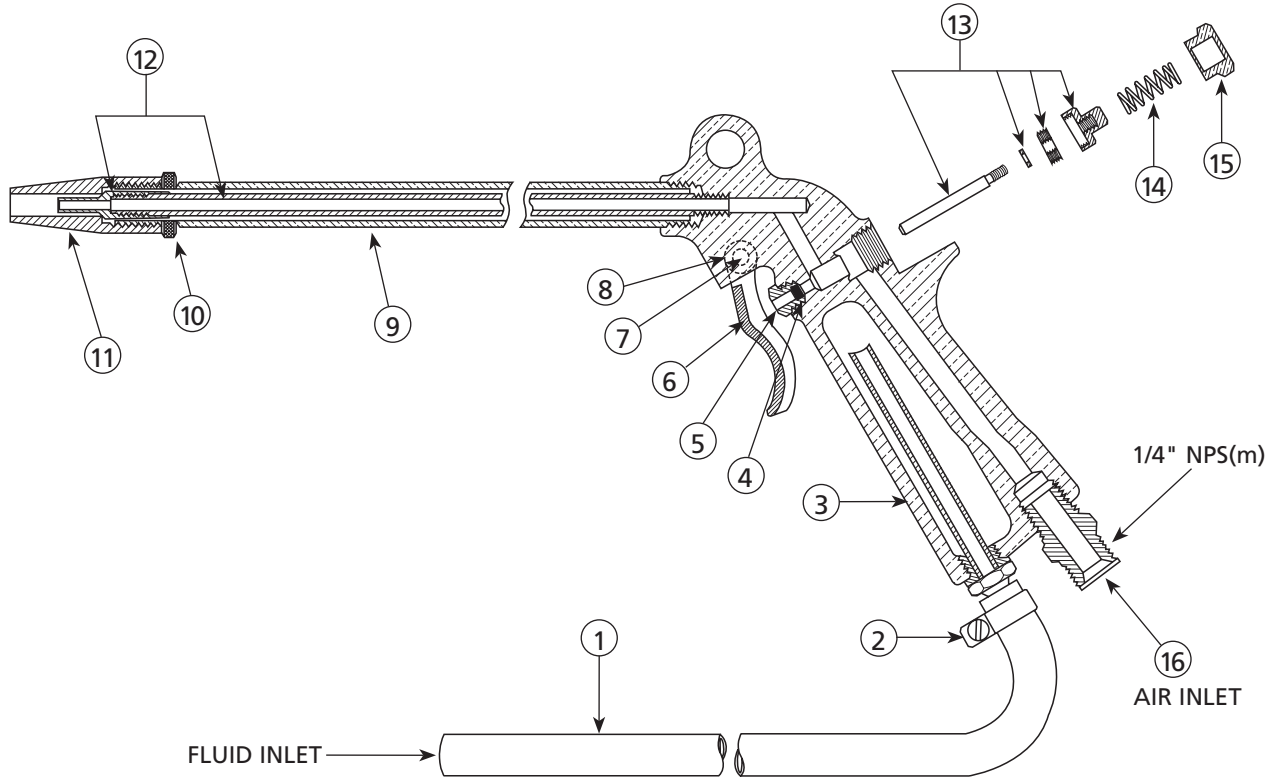

The Binks Model 140B spray gun is used for spraying solvents to clean engines and other machinery. Gun has a brass body with a ten inch nozzle/tube length. Flexible tubing is attached to the gun handle with a hose clamp for

siphoning solvent from container. 1/4" NPS(m) air inlet. Requires 14 CFM air at 50 PSI. Working CFM can range from 8-1/2 to 18-1/2 CFM and from 40 to 100 PSI. Gun weight (less hose): 1.37 lbs.

PARTS LIST

When ordering, please specify Part No.

ITEM NO.	PART NO.	DESCRIPTION	QTY.	ITEM NO.	PART NO.	DESCRIPTION	QTY.
1	●	SUCTON HOSE 1/4" I.D. x 6' Long...	1	13	57-179	AIR VALVE ASSEMBLY	1
2	20-1817■	HOSE CLAMP			57-99■	STEM	
3	57-102■	BODY ASSEMBLY			57-125▲	WASHER	
4	82-158★	PACKING	2		58-3	VALVE DISC RETAINER	
5	57-89	PACKING NUT	1		58-4	VALVE DISC	
6	57-116	TRIGGER	1	14	57-100	AIR VALVE SPRING.....	1
7	57-117▲	TRIGGER SHAFT	1	15	57-96★	AIR VALVE CAP	1
8	20-2994★▲	E-CLIP	2	16	57-13★	AIR CONNECTION	1
9	57-93★	OUTSIDE TUBE	1				
10	57-8*	NOZZLE LOCK NUT.....	1				
11	57-92*	OUTSIDE NOZZLE	1				
12	57-101	AIR TUBE ASSEMBLY	1				
	57-94	NOZZLE					
	57-95★	TUBE					

* Note: To adjust fluid flow, loosen nut (10) and turn nozzle (11).

■ Items NOT available separately.

★ Available from Binks distributors only.

▲ Available in Quantity Pak of 5.

● Cut from bulk hose 71-10000 (available from Binks distributors).

In this part sheet, the words **WARNING**, **CAUTION** and **NOTE** are used to emphasize important safety information as follows:

⚠ WARNING
 Hazards or unsafe practices which could result in severe personal injury, death or substantial property damage.

⚠ CAUTION
 Hazards or unsafe practices which could result in minor personal injury, product or property damage.

NOTE
 Important installation, operation or maintenance information.

⚠ WARNING

Read the following warnings before using this equipment.



READ THE MANUAL
 Before operating finishing equipment, read and understand all safety, operation and maintenance information provided in the operation manual.



WEAR SAFETY GLASSES
 Failure to wear safety glasses with side shields could result in serious eye injury or blindness.



DE-ENERGIZE, DEPRESSURIZE, DISCONNECT AND LOCK OUT ALL POWER SOURCES DURING MAINTENANCE
 Failure to De-energize, disconnect and lock out all power supplies before performing equipment maintenance could cause serious injury or death.



OPERATOR TRAINING
 All personnel must be trained before operating finishing equipment.



EQUIPMENT MISUSE HAZARD
 Equipment misuse can cause the equipment to rupture, malfunction, or start unexpectedly and result in serious injury.



KEEP EQUIPMENT GUARDS IN PLACE
 Do not operate the equipment if the safety devices have been removed.

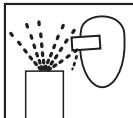

PROJECTILE HAZARD
 You may be injured by venting liquids or gases that are released under pressure, or flying debris.



PINCH POINT HAZARD
 Moving parts can crush and cut. Pinch points are basically any areas where there are moving parts.



AUTOMATIC EQUIPMENT
 Automatic equipment may start suddenly without warning.



INSPECT THE EQUIPMENT DAILY
 Inspect the equipment for worn or broken parts on a daily basis. Do not operate the equipment if you are uncertain about its condition.



NEVER MODIFY THE EQUIPMENT
 Do not modify the equipment unless the manufacturer provides written approval.



KNOW WHERE AND HOW TO SHUT OFF THE EQUIPMENT IN CASE OF AN EMERGENCY



PRESSURE RELIEF PROCEDURE
 Always follow the pressure relief procedure in the equipment instruction manual.



NOISE HAZARD
 You may be injured by loud noise. Hearing protection may be required when using this equipment.



STATIC CHARGE
 Fluid may develop a static charge that must be dissipated through proper grounding of the equipment, objects to be sprayed and all other electrically conductive objects in the dispensing area. Improper grounding or sparks can cause a hazardous condition and result in fire, explosion or electric shock and other serious injury.



FIRE AND EXPLOSION HAZARD
 Never use 1,1,1-trichloroethane, methylene chloride, other halogenated hydrocarbon solvents or fluids containing such solvents in equipment with aluminum wetted parts. Such use could result in a serious chemical reaction, with the possibility of explosion. Consult your fluid suppliers to ensure that the fluids being used are compatible with aluminum parts.



TOXIC FLUID & FUMES
 Hazardous fluid or toxic fumes can cause serious injury or death if splashed in the eyes or on the skin, inhaled, injected or swallowed. LEARN and KNOW the specific hazards of the fluids you are using.



WEAR RESPIRATOR
 Toxic fumes can cause serious injury or death if inhaled. Wear a respirator as recommended by the fluid and solvent manufacturer's Material Safety Data Sheet.



PROP 65 WARNING
 WARNING: This product contains chemicals known to the State of California to cause cancer and birth defects or other reproductive harm.

FOR FURTHER SAFETY INFORMATION REGARDING BINKS AND DEVILBISS EQUIPMENT, SEE THE GENERAL EQUIPMENT SAFETY BOOKLET (77-5300).

WARRANTY

This product is covered by Binks' 1 Year Limited Warranty.

Binks Sales and Service: www.binks.com

Binks

Binks has authorized distributors throughout the world. For technical assistance or the distributor nearest you, see listing below.

U.S.A./Canada Customer Service Office:

195 Internationale Blvd., Glendale Heights, IL 60139
 Toll-Free Telephone: 1-800-992-4657 (U.S.A. and Canada only)
 Toll-Free Fax: 1-888-246-5732

DeVilbiss Automotive Refinishing

Binks has authorized distributors throughout the world. For equipment, parts and service, check the Yellow Pages under "Automotive Body Shop Equipment and Supplies." For technical assistance, see listing below.

U.S.A./Canada Customer Service Office:

11360 S. Airfield Road, Swanton, OH 43558
 Toll-Free Telephone: 1-800-445-3988 (U.S.A. and Canada only)
 Toll-Free Fax: 1-800-445-6643



77-1191R-11 Revisions: Trademark updates.