

## OPERATION MANUAL 903348 (BHV) HVLP GRAVITY FEED SPRAYGUN

### IMPORTANT:

Read and follow all instructions and SAFETY PRECAUTIONS before using this equipment.

### DESCRIPTION

The BHV gravity spraygun is fitted with a 1.3 mm fluid tip for topcoat applications. A 1.4 mm fluid tip is also included.

**Important:** This spraygun is suitable for use with solvent-based coating materials. The design uses HVLP (high volume, low pressure) technology to reduce overspray and improve coating efficiency. This gun produces approximately 10 psi air cap pressure at 30 psi gun inlet pressure (complies with rules issued by SCAQMD and other air quality authorities.) Nozzles and needles are manufactured in stainless steel. These guns are not designed for use with highly corrosive and/or abrasive materials and if used with such materials it must be expected that the need for cleaning and/or replacement of parts will be increased. If there is any doubt regarding the suitability of a specific material, contact your local Distributor or DeVilbiss Automotive Refinishing direct.

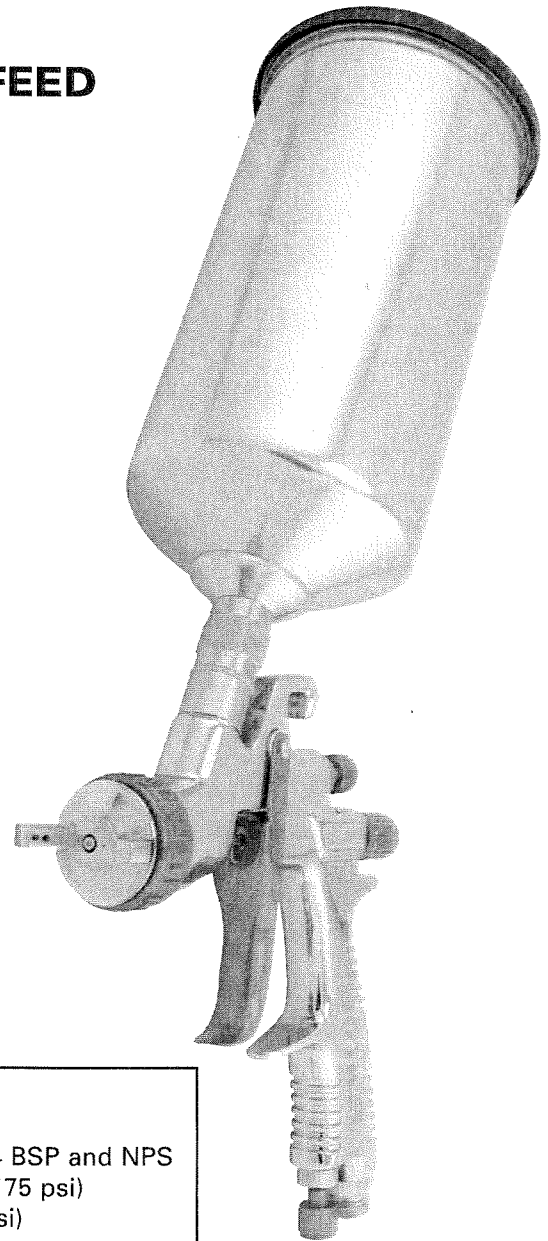

### SPECIFICATIONS











Air supply connection .....	Universal 1/4 BSP and NPS
Maximum static air inlet pressure .....	$P_1 = 12$ bar (175 psi)
Nominal gun inlet pressure with gun triggered .....	2.1 bar (30 psi)
Maximum service temperature .....	40°C (104°F)
Gun weight (gun only) .....	430 g (15.2 oz)
Air flow .....	370 l/min (13.0 cfm)
Cup capacity .....	1 liter (34 oz)

### Materials of Construction

Gun body .....	Aluminum
Nozzle .....	Stainless steel (303)
Needle .....	Stainless steel (303)
Fluid passageway .....	Stainless steel (303)
Cup .....	Aluminum and plated brass



**SAFETY WARNINGS**

   	<p><b>FIRE AND EXPLOSION</b></p> <p>Solvents and coating materials can be highly flammable or combustible when sprayed. <b>ALWAYS refer to the coating material suppliers instructions and MSDS sheets before using this equipment.</b></p> <p>Users must comply with all local and national codes of practice and insurance company requirements governing ventilation, fire precautions, operation and house-keeping of working areas.</p> <p><b>This equipment, as supplied, is <u>NOT</u> suitable for use with <u>Halogenated Hydrocarbons</u>.</b></p> <p>Static Electricity can be generated by fluid and/or air passing through hoses, by the spraying process and by cleaning non- conductive parts with cloths. To prevent ignition sources from static discharges, earth continuity must be maintained to the spraygun and other metallic equipment used. It is essential to use conductive air and/or fluid hoses.</p>
    	<p><b>PERSONAL PROTECTIVE EQUIPMENT</b></p> <p><b>Toxic vapors</b> – When sprayed, certain materials may be poisonous, create irritation or be otherwise harmful to health. Always read all labels and safety data sheets for the material before spraying and follow any recommendations. <b>If In Doubt, Contact Your Material Supplier.</b></p> <p>The use of respiratory protective equipment is recommended at all times. The type of equipment must be compatible with the material being sprayed.</p> <p>Always wear eye protection when spraying or cleaning the spraygun</p> <p>Gloves must be worn when spraying or cleaning the equipment.</p> <p><b>Training</b> – Personnel should be given adequate training in the safe use of spraying equipment.</p>
	<p><b>MISUSE</b></p> <p>Never aim a spraygun at any part of the body.</p> <p>Never exceed the max. recommended safe working pressure for the equipment.</p> <p>The fitting of non-recommended or non-original spares may create hazards.</p> <p>Before cleaning or maintenance, all pressure must be isolated and relieved from the equipment.</p> <p>The product should be cleaned using a gun washing machine. However, this equipment should not be left inside gun washing machines for prolonged periods of time.</p>
	<p><b>NOISE LEVELS</b></p> <p>The A-weighted sound level of sprayguns may exceed 85 dB (A) depending on the set-up being used. Details of actual noise levels are available on request. It is recommended that ear protection is worn at all times when spraying.</p>
	<p><b>OPERATING</b></p> <p>Spray Equipment using high pressures may be subject to recoil forces. Under certain circumstances, such forces could result in repetitive strain injury to the operator.</p>

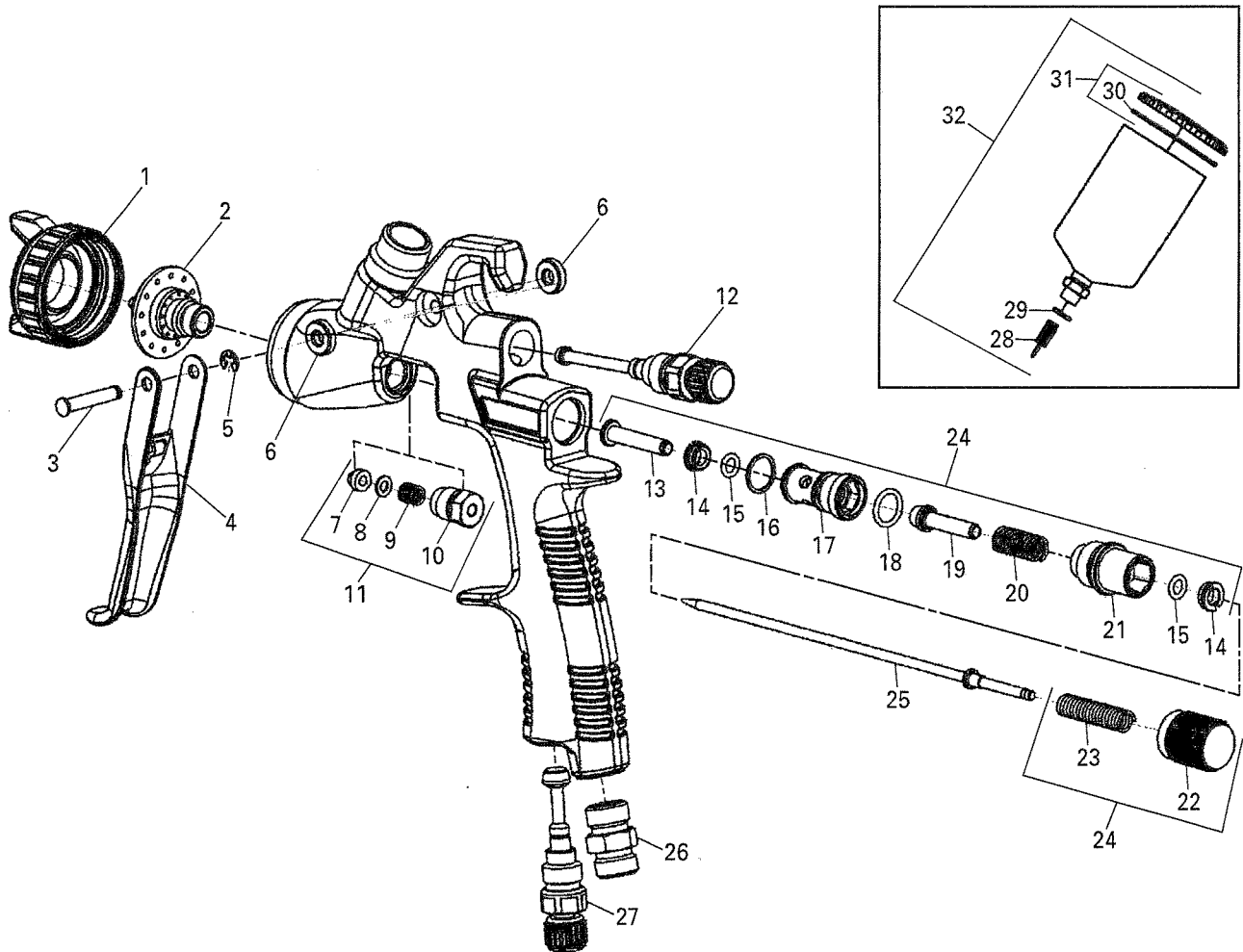

**PARTS LIST**

Ref. No.	Part No.	Description	Qty.
1	903351	Air Cap	1
2	▼	Fluid Tip	1
3	▼	Trigger Stud	1
4	▼	Trigger	1
5	▼	Retaining Ring	1
6	▼	Spacer	2
7	•	Packing	1
8	•	Washer	1
9	•	Packing Spring	1
10		Packing Nut	1
11	903352	Packing & packing Nut Kit	1
12	903353	Pattern Adjusting Valve	1
13		Air Valve Shaft	1
14	•	Seal Retainer	2
15	•	O-Ring (PTFE )	2
16	•	O-Ring	1
17		Air Valve Cage	1
18	•	O-Ring	1
19		Air Valve Seat Set	1
20	•	Air Valve Spring	1
21		Air Valve Bushing	1

Ref. No.	Part No.	Description	Qty.
22		Fluid Adjusting Knob	1
23	•	Needle Spring	1
24	903354	Air Valve Kit	1
25	Δ	Fluid Needle	1
26	903355	Air Inlet Fitting	1
27	903356	Air Adjusting Valve	1
28	KGP-5-K5	Filter	1
29	*	Cup Gasket	1
30	*	Lid Gasket	1
31	903357	Lid & Gasket (Kit of 2 each)	1
32	802346	600cc Aluminum Cup & Lid	1
32	803070	1000cc Aluminum Cup & Lid	1

Δ	903358	1.3 Tip & Needle Kit
Δ	903359	1.4 Tip & Needle Kit
•	903360	Repair Kit (7, 8, 9, 14x2, 15x2, 16, 18, 20, 23)
▼	903361	Trigger Kit (3, 4, 5, 6x2)
*	802427	Cup Gasket Kit (29x2, 30x2)

## INSTALLATION

**Important:** To ensure that this equipment reaches you in first class condition, protective coatings have been used. *Flush the equipment through with a suitable solvent before use.*

1. Attach air hose to connector (26). Recommended hose size 8 mm bore. The hose must be conductive and electrical bond from the spraygun to earth should be checked with an ohmmeter. A resistance of less than  $10^6$  ohms is recommended.
2. Air supply should be filtered and regulated.

## OPERATION

1. Mix coating material to manufacturers instructions.
2. Turn needle adjusting screw (22) counter-clockwise until first thread shows.
3. Turn pattern valve (12) counter-clockwise to fully open.
4. Adjust inlet air pressure to give 2.1 bar (30 psi) at the gun inlet with the gun triggered. (*pressure gauge attachment shown under Accessories is recommended for this*).
5. Test spray. If the finish is too dry, reduce air flow by reducing inlet pressure. If finish is too wet, reduce fluid flow by turning needle screw (18) clockwise. If atomisation is too coarse, increase inlet air pressure. If too fine, reduce inlet pressure.
6. The pattern size can be reduced by adjusting valve (10).
7. Hold gun perpendicular to surface being sprayed. Arcing or tilting may result in uneven coating.
8. The recommended spray distance is 150-200 mm (6"-8").
9. Spray edges first. Overlap each stroke a minimum of 50%. Move gun at a constant speed.
10. Always turn off air supply and relieve pressure when gun is not in use.

## PREVENTATIVE MAINTENANCE

1. Turn off air supply and relieve pressure in the airline or, if using QD system, disconnect from airline.
2. Empty coating material into a suitable container and clean the gun and cup, preferably in a gun wash machine.
3. **IMPORTANT- the cup must not be cleaned or rubbed with a dry cloth or paper. It is possible to generate a static charge by rubbing which, if discharged to an earthed object, could create an incentive spark and cause solvent vapours to ignite. Only use a dampened cloth or antistatic wipes if additional cleaning is required within a hazardous area.**
4. Remove air cap (2) and clean. If any of the holes in the cap are blocked with coating material, only use the cleaning kit 192212 (see accessories) which has the correct tools for this, or a toothpick to clean. Using any other tool could damage the cap and produce distorted spray patterns.
5. Ensure the tip of the nozzle is clean and free from damage. Build-up of dried paint can distort the spray pattern.
6. Lubrication – Trigger stud (3), needle (25) and air-valve spindle (13) should be oiled each day.

### WARRANTY

This product is covered by DeVilbiss' 1 Year Limited Warranty.

---

**DeVilbiss Worldwide Sales and Service Listing: [www.autorefinishdevilbiss.com](http://www.autorefinishdevilbiss.com)**

---

### DeVilbiss Automotive Refinishing

DeVilbiss has authorized distributors throughout the world. For equipment, parts and service, check the Yellow Pages under "Automotive Body Shop Equipment and Supplies." For technical assistance, see listing below.

**U.S./Canada Customer Service Office:**  
11360 S. Airfield Road, Swanton, OH 43558  
Toll-Free Telephone: 1-800-445-3988 (U.S.A. and Canada only)  
Toll-Free Fax: 1-800-445-6643

