

# BINKS SV100 HVLP GRAVITY FEED SPRAY GUN 7042-6931-4



The following instructions provide the necessary information for the proper maintenance of the Binks SV100 gravity feed spray gun. Please read and understand all the information in this document in order to get the maximum performance from your new SV100 gravity spray gun.

The SV100 spray gun is the result of quality engineering and development activity. The result is an ergonomic product with reduced triggering effort and fine atomization. The HVLP air cap has been specifically designed to comply with local regulatory air quality restrictions. The specification table details the operating parameters of the gun to achieve those compliant conditions. In addition, the relatively low air flow rate of the SV100 spray gun will help in containing overspray.

The SV100 spray gun should be operated under the safety directions outlined in this literature. Your safety and the safety of others depend on your thorough understanding of the material contained on the Part Sheet.

If you have any questions or do not understand the content in this literature, call your nearest service representative.

## SPECIFICATIONS

Max. Air Pressure:	175psi/12bar
For HVLP Compliance:	26 psi inlet pressure delivers (with SV100-693K cap) 10 psi air cap pressures at 12 cfm air volume
Gun Body:	Cast Aluminum
Fluid Path:	Aluminum
Fluid Nozzle:	Stainless Steel
Fluid Needle:	Stainless Steel
Fluid Inlet Size:	3/8"-19 BSP(F)
Air Inlet Size;	1/4" NPS(M)
Gun Weight:	1.02 lbs. (461 g)



In this part sheet, the words **WARNING**, **CAUTION** and **NOTE** are used to emphasize important safety information as follows:

## **WARNING**

Hazards or unsafe practices which could result in severe personal injury, death or substantial property damage.

## **CAUTION**

Hazards or unsafe practices which could result in minor personal injury, product or property damage.

## **NOTE**

Important installation, operation or maintenance information.

## **WARNING**

### Read the following warnings before using this equipment.



#### READ THE MANUAL

Before operating finishing equipment, read and understand all safety, operation and maintenance information provided in the operation manual.



#### OPERATOR TRAINING

All personnel must be trained before operating finishing equipment.



#### EQUIPMENT MISUSE HAZARD

Equipment misuse can cause the equipment to rupture, malfunction, or start unexpectedly and result in serious injury.



#### LOCK OUT / TAG-OUT

Failure to de-energize, disconnect, lock out and tag-out all power sources before performing equipment maintenance could cause serious injury or death.



#### AUTOMATIC EQUIPMENT

Automatic equipment may start suddenly without warning.



#### PRESSURE RELIEF PROCEDURE

Always follow the pressure relief procedure in the equipment instruction manual.



#### KEEP EQUIPMENT GUARDS IN PLACE

Do not operate the equipment if the safety devices have been removed.



#### KNOW WHERE AND HOW TO SHUT OFF THE EQUIPMENT IN CASE OF AN EMERGENCY



#### WEAR SAFETY GLASSES

Failure to wear safety glasses with side shields could result in serious eye injury or blindness.



#### INSPECT THE EQUIPMENT DAILY

Inspect the equipment for worn or broken parts on a daily basis. Do not operate the equipment if you are uncertain about its condition.



#### NEVER MODIFY THE EQUIPMENT

Do not modify the equipment unless the manufacturer provides written approval.



#### NOISE HAZARD

You may be injured by loud noise. Hearing protection may be required when using this equipment.

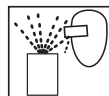

#### PROJECTILE HAZARD

You may be injured by venting liquids or gases that are released under pressure, or flying debris.



#### PINCH POINT HAZARD

Moving parts can crush and cut. Pinch points are basically any areas where there are moving parts.



#### STATIC CHARGE

Fluid may develop a static charge that must be dissipated through proper grounding of the equipment, objects to be sprayed and all other electrically conductive objects in the dispensing area. Improper grounding or sparks can cause a hazardous condition and result in fire, explosion or electric shock and other serious injury.



#### WEAR RESPIRATOR

Toxic fumes can cause serious injury or death if inhaled. Wear a respirator as recommended by the fluid and solvent manufacturer's Material Safety Data Sheet.



#### TOXIC FLUID & FUMES

Hazardous fluid or toxic fumes can cause serious injury or death if splashed in the eyes or on the skin, inhaled, injected or swallowed. LEARN and KNOW the specific hazards or the fluids you are using.



#### FIRE AND EXPLOSION HAZARD

Improper equipment grounding, poor ventilation, open flame or sparks can cause a hazardous condition and result in fire or explosion and serious injury.



#### MEDICAL ALERT

Any injury caused by high pressure liquid can be serious. If you are injured or even suspect an injury:

- Go to an emergency room immediately.
- Tell the doctor you suspect an injection injury.
- Show the doctor this medical information or the medical alert card provided with your airless spray equipment.
- Tell the doctor what kind of fluid you were spraying or dispensing.



#### GET IMMEDIATE MEDICAL ATTENTION

To prevent contact with the fluid, please note the following:

- Never point the gun/valve at anyone or any part of the body.
- Never put hand or fingers over the spray tip.
- Never attempt to stop or deflect fluid leaks with your hand, body, glove or rag.
- Always have the tip guard on the spray gun before spraying.
- Always ensure that the gun trigger safety operates before spraying.



CA PROP  
**65**

#### PROP 65 WARNING

WARNING: This product contains chemicals known to the State of California to cause cancer and birth defects or other reproductive harm.

**IT IS THE RESPONSIBILITY OF THE EMPLOYER TO PROVIDE THIS INFORMATION TO THE OPERATOR OF THE EQUIPMENT. FOR FURTHER SAFETY INFORMATION REGARDING THIS EQUIPMENT, SEE THE GENERAL EQUIPMENT SAFETY BOOKLET (77-5300).**

Binks reserves the right to modify equipment specification without prior notice.

## OPERATION AND MAINTENANCE INSTRUCTIONS

Your new SV100 Gravity Feed Spray Gun is exceptionally rugged in construction and is built to stand up under hard, continuous use. However, like any other fine precision instrument, its most efficient operation depends on a knowledge of its construction, operation, and maintenance. Properly handled and cared for, it will produce beautiful, uniform finishing results long after other spray guns have worn out.

### SET-UP FOR SPRAYING (Figure 1) CONNECTING GUN TO AIR HOSE

Air should be supplied by a suitable length of 5/16" diameter air hose fitted with a 1/4 NPS(f) connection at base of gun handle. For hose lengths over 50', use 3/8" hose.

### CONNECTING GRAVITY FEED CUP TO GUN

Insert gasket and screw the cup into the spray gun fluid inlet. Insert strainer, if used, and fill the cup with filtered paint.

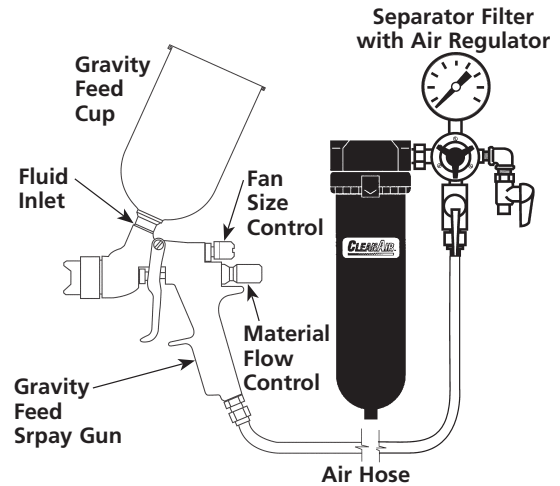

Figure 1

## OPERATING THE SV100 GRAVITY FEED SPRAY GUN

### CONTROLLING THE MATERIAL FLOW

Correct fluid nozzle size should be selected for proper material flow rate. The material valve control knob may be used to restrict the material needle valve opening and reduce the material flow as necessary.

### CONTROLLING THE FAN SPRAY

The fan spray is controlled by means of the spray pattern valve control assembly. Turning this control clockwise until it is closed will give a round spray. Turning it counterclockwise will widen the spray into a fan shape. The fan spray can be turned anywhere through 360° by positioning the air cap relative to the gun. To affect this, loosen retainer ring, position nozzle, then tighten retainer ring.

## TROUBLE SHOOTING

### FAULTY SPRAY

A faulty spray is often caused by improper cleaning resulting in dried materials around the material nozzle tip or in the air nozzle. Soak these parts in thinners to soften the dried material and remove with a brush or cloth. If either the air cap or fluid nozzle are damaged, these parts must be replaced before perfect spray can be obtained.

### **CAUTION**

Never use metal instruments to clean the air or material nozzles. These parts are carefully machined and any damage to them will cause faulty spray.

### INTERMITTENT SPRAY

Fluttering spray is caused by one of the following:

1. Insufficient material in cup. Refill the cup.
2. Loose fluid nozzle. Tighten snugly.
3. Cup connection loose or dirt in connection. Correct as necessary.
4. Air vent in gravity cup blocked. Clear obstruction.

## SPRAY GUN CLEANING INSTRUCTIONS

In certain states, spraying solvents which contain Volatile Organic Compounds (VOC) into the atmosphere when cleaning a spray gun is now prohibited.

In order to comply with these new air quality laws, Binks recommends one of the following two methods to clean your spray finishing equipment.

1. Spray solvent through the gun into a *closed system*. An enclosed unit or spray gun cleaning station condenses solvent vapors back into liquid form which prevents escape of VOCs into the atmosphere.
2. Place spray gun in a washer type cleaner. This system must

totally enclose the spray gun, cups, nozzles and other parts during washing, rinsing and draining cycles. This type of unit must be able to flush solvent through the gun without releasing any VOC vapors into the atmosphere.

### CLEANING GUN AND GRAVITY FEED CUP

Remove the cup cover and drain unused material from cup. Carefully rinse cup with solvent. Place clean solvent into the cup and spray this through the gun until it is clean. Remove and clean the cup if necessary. Blow air through the gun to dry it. (Refer to Service Bulletin SBBI-4-043 for cleaning instructions when using cup liners.)

## GENERAL SPRAY INSTRUCTIONS

To reduce overspray and obtain maximum efficiency, always spray with the lowest possible fluid/air pressure that produces an acceptable spray pattern.

Excessive atomizing air pressure can increase overspray, reduce transfer efficiency and with some materials, result in poor finish quality from dry spray.

Generally use up to 20 psi air at gun inlet. Unusually heavy, difficult to atomize materials may require up to 26 psi at gun inlet. See *Specifications* on page 1.

## SPRAY TECHNIQUE

The first requirement for a good resultant finish is the proper handling of the gun. The gun should be held perpendicular to the surface being covered and moved parallel with it. The stroke should be started before the trigger is pulled and the trigger should be released before the stroke is ended. This gives accurate control of the gun and material.

The distance between gun and surface should be 6 to 8 inches depending on material and atomizing pressure. The material deposited should always be even and wet. Lap each stroke over the preceding stroke to obtain a uniform finish. Use 50% overlap.

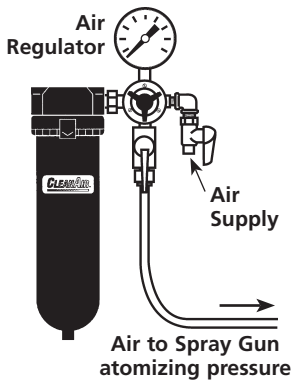
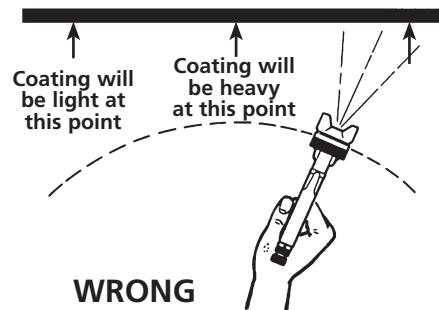
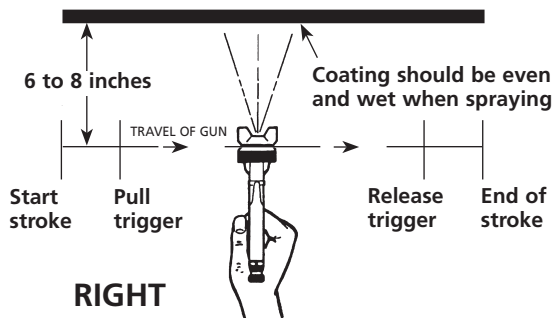

## SEPARATOR FILTER

Achieving a fine spray finish without the use of a good separator filter is virtually impossible.

A regulator/separator filter serves a double purpose. It eliminates blistering and spotting by keeping air free of oil and water and it gives precise air pressure control at the gun.

Atomizing pressure must be set to allow for the drop in air pressure between the regulator and the spray gun.

Binks recommends Model HFRL-508 Separator/Filter Regulator.

## HOSE SIZE RECOMMENDATIONS WITH 60 PSI APPLIED AT AIR SUPPLY

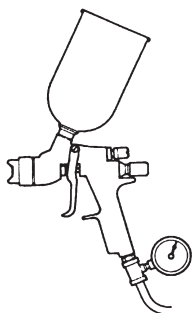

**Only 43 psi at gun inlet**

25 feet of 1/4" I.D. hose causes a drop of 17 psi between the air supply and the gun.

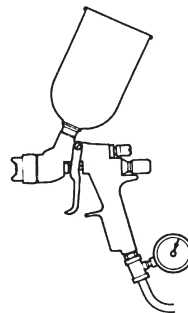

**54 psi at gun inlet**

25 feet of 5/16" I.D. causes a drop of 6 psi between the air supply and the gun. For this reason we recommend the use of 5/16" hose.

Not Recommended



1/4"

Cross section view showing comparison of inside diameter of air hose (actual size). 60 lbs. regulated pressure.



5/16"

Recommended

**BINKS SV100 HVLP GRAVITY FEED SPRAY GUN**

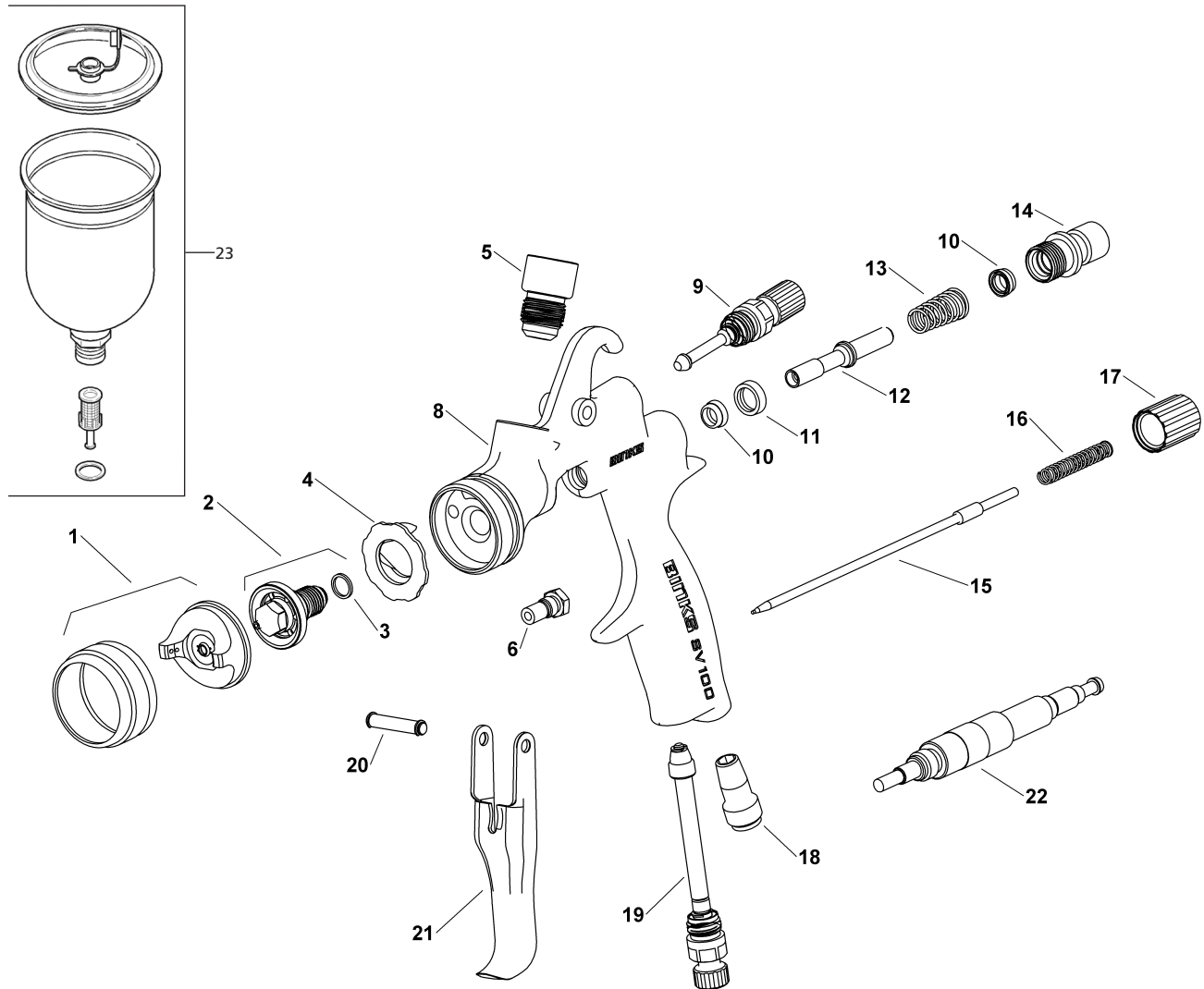

**PARTS LIST**

(When ordering, please specify Part No.)

ITEM NO.	PART NO.	DESCRIPTION	QTY.	ITEM NO.	PART NO.	DESCRIPTION	QTY.
1	SV100-693K	AIR CAP .....	1	15★	—	FLUID NEEDLE 1.4 mm .....	1
2★	—	FLUID TIP 1.4 mm w/GASKET .....	1	15a★•	—	FLUID NEEDLE 2.0 mm .....	1
2a★•	—	FLUID TIP 2.0 mm w/GASKET .....	1	16★•	—	FLUID NEEDLE SPRING .....	1
3■	—	GASKET .....	1	17	—	FLUID ADJUSTMENT KNOB .....	1
4★•▲	—	BAFFLE .....	1	18	—	NIPPLE .....	1
5	—	FLUID NIPPLE .....	1	19	SGK-457	AIR ADJUSTING VALVE ASSEMBLY ....	1
6★■•▲	—	PACKING w/NUT .....	1	20	—	TRIGGER PIN ASSEMBLY .....	1
8	—	GUN BODY .....	1	21	—	TRIGGER .....	1
9	SGK-455	SPRAY PATTERN VALVE .....	1	22■	—	ASSEMBLY TOOL .....	1
10■	—	U-CUP SEAL .....	2	23	54-4720	1L GRAVITY CUP (ALUMINUM) .....	1
11■	—	AIR VALVE SEAT .....	1				
12	—	AIR VALVE STEM .....	1				
13■	—	AIR VALVE SPRING .....	1				
14	—	AIR VALVE BUSHING .....	1				

★ K-5053 Gravity Gun Fluid Tip and Needle Replacement Kit (includes 1.4 and 2.0 mm tips)

■ K-5057 Soft Parts Kit

• K-5053-20 Gravity Gun Fluid Tip and Needle Replacement Kit (includes 2.0 mm tip)

▲ SGK-537-K Baffle and 5 ea. Packings

**AIR NOZZLE, FLUID NOZZLE, FLUID NEEDLE****NOTE**

To reduce overspray and obtain maximum efficiency always spray with the lowest possible atomizing air pressure.

1. All nozzles and needles are precision made. They should be handled with care.
2. Do not make any alterations in the gun. To do so could cause finishing difficulties.
3. To clean nozzles, soak them in solvent to dissolve any dried material, then blow them clean with air.
4. Do not probe any of the holes in the nozzles with metal instruments. If probing is necessary, use only a tool that is softer than brass.

**⚠ CAUTION**

Never use metal instruments to clean the air or fluid nozzles.  
These parts are carefully machined and any damage to them will cause faulty spray.

**ACCESSORIES**

**GFC-501 (Acetal) 20 Oz. Cup**  
**54-4720 (Aluminum) 1-Liter Cup**  
**Gravity Feed Cups**

These gravity feed cups are designed to be used with EXL, FLG, Compact, SV100, 95G and M1-G gravity feed spray guns.

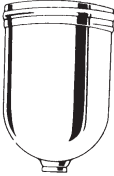

**Spray Gun Lube**  
**SSL-10-K12 (2 oz. bottle)**

Compatible with all paint materials; contains no silicone or petroleum distillates to contaminate paint. MSDS Sheet available upon request.



**Industrial Quick Connects**  
**for HVLG Guns (Air)**

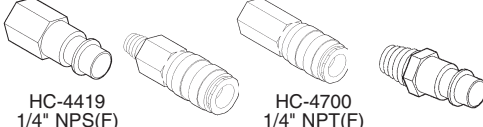

HC-4419 1/4" NPS(F)    HC-4699 1/4" NPT(M)    HC-4700 1/4" NPT(F)    HC-1166 1/4" NPT(M)

**DeKups Cup System & Adapter**

DPC-607 Reusable Cup 9 oz – Kit of 2  
 DPC-606 Reusable Cup 24oz – Kit of 2  
 DPC-608 Reusable Cup 34 oz – Kit of 2

DPC-602 Disposable Cup 9 oz – Kit of 32  
 DPC-601 Disposable Cup 24 oz – Kit of 32  
 DPC-600 Disposable Cup 34 oz – Kit of 32

DPC-31 Adapter

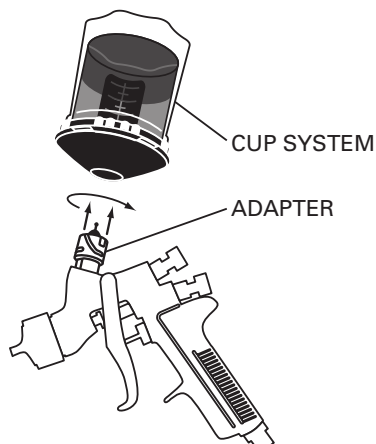

CUP SYSTEM  
 ADAPTER

**Cleaning Brushes**  
**42884-214-K5 (3/8")**  
**42884-215-K10 (5/8")**

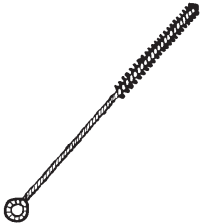

These brushes are helpful in cleaning threads and recesses of gun body.

**HAF-507**  
**Whirlwind™**  
**In-Line Air Filter**

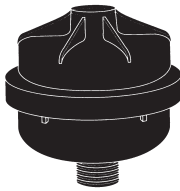

Removes water, oil, and debris from the air line.

**OMX-70-K48**  
**Paint Cup Liner Kit**

Allows quick & easy clean-up.

**Consists of :**  
 1 - Piercing Tool  
 48 - Disposable Liners  
 48 - Drain Bushings

**GFC-404-K2**  
**Disposable Lid Kit**



Kit of 2.

**29-3100-K6 Scrubs®**  
**Hand Cleaner Towels**



Scrubs® are a pre-moistened hand cleaner towel for painters, body men and mechanics that go where you go and no water is needed.

**KGP-5-K5**  
**Paint Filter Kit (Gravity)**



Gravity cup strainers, 50 mesh, package of 5.

**Paint Spray Respirators**

**40-141 (Sm)**  
**40-128 (Med)**  
**40-143 (Lg)**

NIOSH-Certified for respiratory protection in atmospheres not immediately dangerous to life.

**KGP-13-K5**  
**Gasket**

Seals gravity cup to gun.  
 Kit of 5.

U.S. Patent Nos. 6,820,824 and 7,374,111 owned by 3M Innovative Properties Co.  
 Additional U.S. Patents: Nos. 7,380,680; 7,354,074; 7,353,964; 7,350,418; 7,344,040; 7,263,893; 7,165,732; 7,086,549.

## WARRANTY POLICY

Binks products are covered by Finishing Brands one year materials and workmanship limited warranty. The use of any parts or accessories, from a source other than Finishing Brands, will void all warranties. For specific warranty information please contact the closest Finishing Brands location listed below.

Finishing Brands reserves the right to modify equipment specifications without prior notice. DeVilbiss®, Ransburg®, BGK®, and Binks® are registered trademarks of Carlisle Fluid Technologies, Inc., dba Finishing Brands. ©2015 Carlisle Fluid Technologies, Inc., dba Finishing Brands. All rights reserved.



Binks is part of Finishing Brands, a global leader in innovative spray finishing technologies. For technical assistance or to locate an authorized distributor, contact one of our international sales and customer support locations below.

### USA/Canada

www.binks.com  
info@carlisleleft.com  
Tel: 1-800-992-4657  
Fax: 1-888-246-5732

### Mexico

www.carlisleleft.com.mx  
ventas@carlisleleft.com.mx  
Tel: 011 52 55 5321 2300  
Fax: 011 52 55 5310 4790

### Brazil

www.devilbiss.com.br  
vendas@carlisleleft.com.br  
Tel: +55 11 5641 2776  
Fax: 55 11 5641 1256

### United Kingdom

www.finishingbrands.eu  
info@carlisleleft.eu  
Tel: +44 (0)1202 571 111  
Fax: +44 (0)1202 573 488

### France

www.finishingbrands.eu  
info@carlisleleft.eu  
Tel: +33(0)475 75 27 00  
Fax: +33(0)475 75 27 59

### Germany

www.finishingbrands.eu  
info@carlisleleft.eu  
Tel: +49 (0) 6074 403 1  
Fax: +49 (0) 6074 403 281

### China

www.finishingbrands.com.cn  
mkt@carlisleleft.com.cn  
Tel: +8621-3373 0108  
Fax: +8621-3373 0308

### Japan

www.ransburg.co.jp  
overseas-sales@carlisleleft.co.jp  
Tel: 081 45 785 6421  
Fax: 081 45 785 6517

### Australia

www.finishingbrands.com.au  
sales@carlisleleft.com.au  
Tel: +61 (0) 2 8525 7555  
Fax: +61 (0) 2 8525 7500

