

## PLUS® HIGH EFFICIENCY SPRAY GUN (SUCTION/PRESSURE)

**IMPORTANT: Before using this equipment, read all safety precautions and instructions. Keep for future use.**

### DESCRIPTION

The Plus® spray gun is a general-purpose, heavy-duty, high-production spray gun suitable for use with most types of materials. It is available in one suction feed version or in two pressure feed versions.

### NOTE

These guns include 300 series stainless steel fluid tips and needles. Guns should not be used with chlorinated solvent materials. See page 2 for potential hazards.

**Important:** These guns may be used with most common coating and finishing materials. They are designed for use with mildly corrosive and non-abrasive materials. If used with other high corrosive or abrasive materials, it must be expected that frequent and thorough cleaning will be required and the necessity for replacement of parts will be increased.

### INSTALLATION

For maximum transfer efficiency, **do not use more pressure than is necessary to atomize the material being applied.**

1. Connect the gun to a clean, moisture and oil free air supply using a hose size of at least 5/16" I.D. hose. Do not use 1/4" I.D. hose (25' x 1/4" hose at 18 CFM has a pressure loss of 25 psi. 25' x 5/16" hose at 18 CFM has a pressure loss of 8 psi).

### NOTE

Depending on hose length, larger I.D. hose may be required. **Do not use more pressure than is necessary to atomize the material being applied.** Excess pressure will create additional overspray and reduce transfer efficiency.

### NOTE

If quick connects are required, use only high flow quick connects approved for HVLP use such as DeVilbiss HC-4419 and HC-4719. Other types will not flow enough air for proper gun operation.

### NOTE

If an air adjusting valve is used at the gun inlet, use DeVilbiss Model HAV-500 or HAV-511. Some competitive adjusting valves have significant pressure drop that can adversely affect spray performance. Models HAV-500 and HAV-511 have minimal pressure drop.

2. Attach the suction feed cup or fluid hose to the material inlet.

### NOTE

Protective coating and rust inhibitors have been used to keep the gun in good condition prior to shipment. Before using the gun, flush it with solvents so that these materials will be removed from fluid passages.

### OPERATION

Mix, prepare and strain the material to be sprayed according to the paint manufacturer's instructions.

Strain material through a 60 or 90 mesh screen.

1. Fill the suction or pressure feed cup with the material. Do not overfill. If using a suction cup, make sure that the cup lid vent hole is clear.
2. Open the spreader adjustment valve (10) (Fan) by turning the valve stem counterclockwise.
3. Open fluid adjusting screw (17) by turning counterclockwise.
4. Turn on air supply and set gun inlet pressure to 40 psi. Some materials can be sprayed at lower pressures, improving transfer efficiency.
5. Turn on the supply air to the pressure cup (if used).
6. Spray a test area.

If the finish is too sandy and dry, the material flow may be too low for the atomization air pressure being used.

If the finish sags, there is too much material flowing for the atomization air pressure being used.

Both of the above can be corrected by increasing or decreasing the atomization air pressure or the material flow. Pattern width can be altered by turning spreader adjustment valve (10), either clockwise to decrease the width or counterclockwise to increase the width.

See Spray Gun Guide, SB-2-001 latest revision, for details concerning setup of spray guns.

### PREVENTIVE MAINTENANCE

To clean air cap and fluid tip, brush exterior with a stiff bristle brush. If necessary to clean cap holes, use a broom straw or toothpick if possible. **If a wire or hard instrument is used, extreme care must be used to prevent scratching or burring of the holes which will cause a distorted spray pattern.**

To clean fluid passages, remove excess material from cup, then flush with a suitable solvent. Wipe gun exterior with a solvent dampened cloth. Never completely immerse in solvent as this is detrimental to the lubricants and packings.

### NOTE

When replacing the fluid tip or fluid needle, replace both at the same time. Using worn parts can cause fluid leakage. See Chart 2. Also, replace the needle packing at this time. Lightly lubricate the threads of the fluid tip before reassembling. Torque to 15-20 ft.-lbs. Do not overtighten the fluid tip.

### CAUTION

**To prevent damage to fluid tip (5) or fluid needle (11), be sure to either 1) pull the trigger and hold while tightening or loosening the fluid tip, or 2) remove fluid needle adjusting screw (17) to relieve spring pressure against needle collar.**

### TRANSFER EFFICIENCY

The DeVilbiss PLUS® suction feed and pressure feed spray guns, when tested under recommended conditions with automotive refinishing materials, have been found to exceed 65% transfer efficiency.

**SAFETY PRECAUTIONS**

This manual contains information that is important for you to know and understand. This information relates to USER SAFETY and PREVENTING EQUIPMENT PROBLEMS. To help you recognize this information, we use the following symbols. Please pay particular attention to these sections.



**Important safety information - A hazard that may cause serious injury or loss of life.**







**Important information that tells how to prevent damage to equipment, or how to avoid a situation that may cause minor injury.**

**NOTE**

Information that you should pay special attention to.



**The following hazards may occur during the normal use of this equipment. Please read the following chart before using this equipment.**

HAZARD	CAUSE	SAFEGUARDS
<b>Fire</b> 	Solvent and coatings can be highly flammable or combustible especially when sprayed.	Adequate exhaust must be provided to keep air free of accumulations of flammable vapors.  Smoking must never be allowed in the spray area.  Fire extinguishing equipment must be present in the spray area.
<b>Solvent Spray</b> 	During use and while cleaning and flushing, solvents can be forcefully expelled from fluid and air passages. Some solvents can cause eye injury.	Wear eye protection.
<b>Inhaling Toxic Substances</b> 	Certain materials may be harmful if inhaled, or if there is contact with the skin.	Follow the requirements of the Material Safety Data Sheet supplied by your coating material manufacturer.  Adequate exhaust must be provided to keep the air free of accumulations of toxic materials.  Use a mask or respirator whenever there is a chance of inhaling sprayed materials. The mask must be compatible with the material being sprayed and its concentration. Equipment must be as prescribed by an industrial hygienist or safety expert, and be NIOSH approved.
<b>Explosion Hazard - Incompatible Materials</b> 	Halogenated hydrocarbon solvents - for example; methylene chloride and 1,1,1, - Trichloroethane are not chemically compatible with the aluminum that might be used in many system components. The chemical reaction caused by these solvents reacting with aluminum can become violent and lead to an equipment explosion.	Due to the aluminum passageways in these guns, they must not be used with these solvents. Aluminum is also widely used in other spray application equipment – such as material pumps, regulators, valves and cups. Check all equipment items before use and make sure they can also be used safely with these solvents. Read the label or data sheet for the material you intend to spray. If in doubt as to whether or not a coating or cleaning material is compatible, contact your material supplier.
<b>General Safety</b>	Improper operation or maintenance of equipment.	Operators should be given adequate training in the safe use and maintenance of the equipment (in accordance with the requirements of NFPA-33, Chapter 15). Users must comply with all local and national codes of practice and insurance company requirements governing ventilation, fire precautions, operation, maintenance, and housekeeping. These are OSHA Sections 1910.94 and 1910.107 and NFPA-33.
<b>Cumulative Trauma Disorders ("CTD's")</b>  <b>CTD's, or musculoskeletal disorders, involve damage to the hands, wrists, elbows, shoulders, neck, and back. Carpal tunnel syndrome and tendinitis (such as tennis elbow or rotator cuff syndrome) are examples of CTD's.</b>	Use of hand tools may cause cumulative trauma disorders ("CTD's").  CTD's, when using hand tools, tend to affect the upper extremities. Factors which may increase the risk of developing a CTD include: <ol style="list-style-type: none"> <li>1. High frequency of the activity.</li> <li>2. Excessive force, such as gripping, pinching, or pressing with the hands and fingers.</li> <li>3. Extreme or awkward finger, wrist, or arm positions.</li> <li>4. Excessive duration of the activity.</li> <li>5. Tool vibration.</li> <li>6. Repeated pressure on a body part.</li> <li>7. Working in cold temperatures.</li> </ol> CTD's can also be caused by such activities as sewing, golf, tennis, and bowling, to name a few.	Pain, tingling, or numbness in the shoulder, forearm, wrist, hands, or fingers, especially during the night, may be early symptoms of a CTD. Do not ignore them. Should you experience any such symptoms, see a physician immediately. Other early symptoms may include vague discomfort in the hand, loss of manual dexterity, and nonspecific pain in the arm. Ignoring early symptoms and continued repetitive use of the arm, wrist, and hand can lead to serious disability. Risk is reduced by avoiding or lessening factors 1-7.



**PROP 65 WARNING**  
 WARNING: This product contains chemicals known to the State of California to cause cancer and birth defects or other reproductive harm.

**SPRAY GUN LUBRICATION**

Daily, apply a drop of SSL-10\* spray gun lube at trigger bearing stud (28) and the stem of air valve (20) where it enters air valve assembly. The shank of fluid needle (11) where it enters packing nut (9) should also be oiled. Fluid needle packing (8) should be lubricated periodically. Make sure baffle (6) and retaining ring (3) threads are clean and free of foreign matter. Before assembling retaining ring to baffle, clean the threads thoroughly, then add two drops of SSL-10 spray gun lube to threads. Fluid needle spring (14) and air valve spring (19) should be coated with a very light grease, making sure that any excess grease will not clog the air passages. For best results, lubricate the points indicated, daily.

\* Not for air tools or high RPM equipment.

- A. Trigger Points
- B. Packing
- C. Adjusting Knobs
- D. Baffle Threads
- E. Air Valve Cartridge

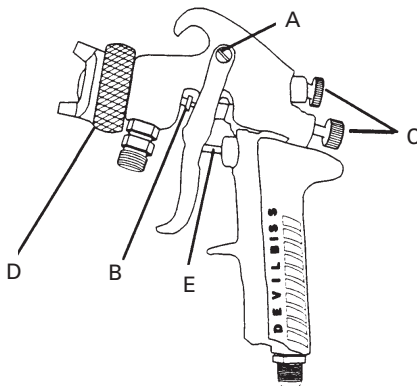

**PARTS REPLACEMENT**

**FLUID INLET GASKET (32) REPLACEMENT INSTRUCTIONS**

1. Remove fluid inlet adapter (34) with appropriate wrench.
2. Clean Loctite from gun body inlet threads and seal area.
3. Place gasket (32) squarely onto the fluid inlet adapter and push it down until it is flat against the shoulder.
4. Use medium strength thread sealant (i.e. Devcon 2242 blue, or equal) on threads before installing fluid inlet adapter.
5. Torque fluid inlet adapter to 20-25 ft. lbs. and tighten locknut.

**PARTS REPLACEMENT**

Figure 1 Air Cap

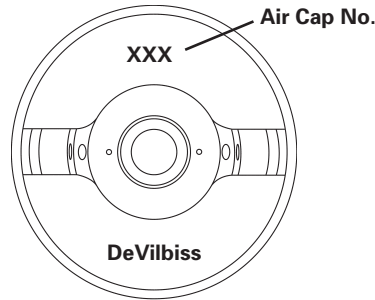

Chart 1

Air Caps, Air Flows and Applications						
No. on Air Cap Order	Air Cap With Ring (Ref. No. 4)	Type of Fluid Delivery S= Suction P= Pressure	Air Flow (CFM)			
			@30 psi	@40 psi	@50 psi	@60 psi
410	AV-440-410	S,P	9	11	13	19
414	AV-440-414	P		14	16.5	19

Chart 2

Fluid Tips and Needles				
Tip Size		Fluid Tip (#5)	Suction Feed Fluid Needle (#11)	Pressure Feed Fluid Needle (#11)
In.	mm			
0.039	1.0	AV-213-10	NR	GTI-449-12
0.047	1.2	AV-213-12	NR	GTI-449-12
0.055	1.4	AV-213-14	GTI-413	GTI-449-12
0.063	1.6	AV-213-16	GTI-413	NR
0.070	1.8	AV-213-18	GTI-413	NR

NR = Not Recommended

**GTI-33 Baffle Seal Replacement**

1. Remove Fluid Tip (5).
2. Remove Baffle (6).
3. Remove Seal (7) from baffle.

**NOTE**

The seal is designed to be a tight fit on the baffle. The seal should be able to be removed using your fingers. If you are unable to remove the seal using your fingers, insert a small screwdriver between the outer lip and the back of the baffle and pry the seal off.

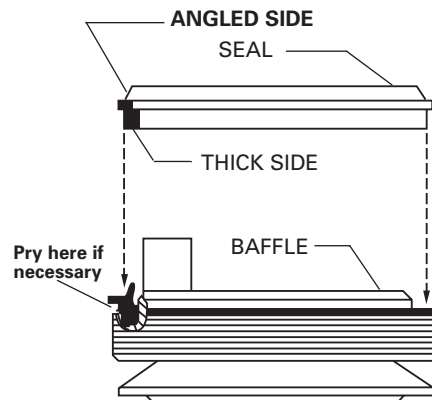

4. Assemble seal to baffle with angled side up as shown in diagram. **NOTE:** The seal should be a tight fit on the baffle. If it is a loose fit on the baffle, assure that it is assembled with the angled side up.
5. Install baffle on gun.
6. Install fluid tip (5) and tighten to 15-20 ft-lbs.

**JGA-4035 Packing Replacement Instructions**

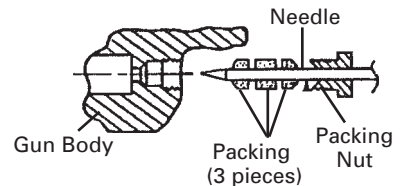

1. Remove adjusting knob and needle spring from gun.
2. Partially withdraw needle from gun body.
3. Loosen packing nut and remove.
4. Remove old packing.
5. Assemble packing nut to needle.
6. Assemble packing in order shown to needle.
7. Insert needle all the way into gun body seating in tip.
8. Install needle spring and adjusting knob.
9. Thread packing nut into gun body.
10. Tighten packing nut in equal increments - no more than 1/6 turn at a time.
11. After each adjustment, pull needle open and observe needle closure.
12. If needle snaps shut, continue adjusting nut until there is evidence of needle bind or slow closing.
13. Back off packing nut 1/12 turn to the point where needle snaps shut. Packing nut must remain tight enough to prevent loosening by hand.
14. Pull needle several times to verify needle snaps shut and check packing nut for looseness.

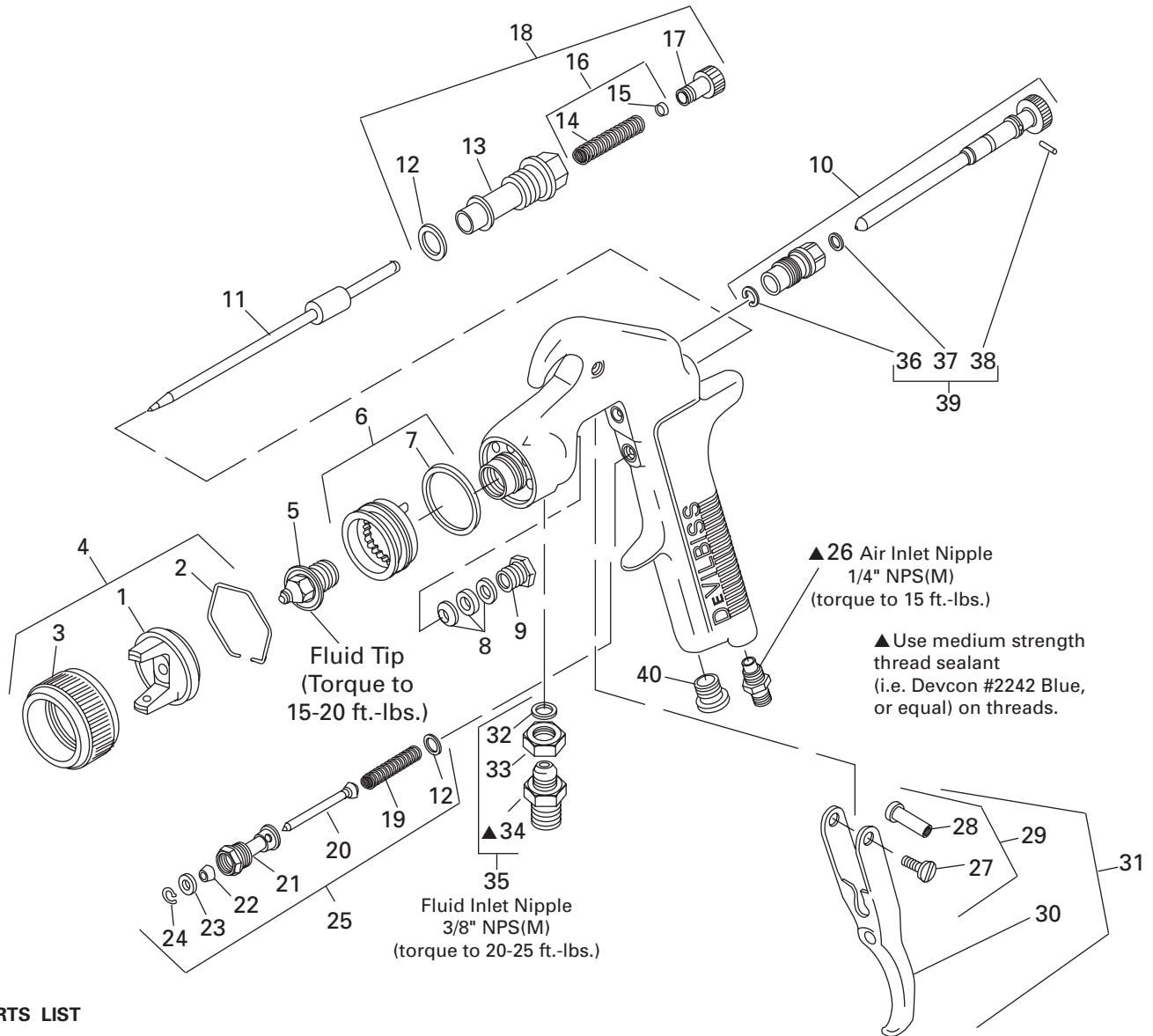





**PARTS LIST**

Ref. No.	Replacement Part No.	Description	Ind. Parts Req.	Ref. No.	Replacement Part No.	Description	Ind. Parts Req.
1	---	Air Cap	1	•20	---	Air Valve	1
2	JGA-156-K10	Spring Clip (Kit of 10)	1	21	---	Air Valve Body	1
3	GTI-3	Air Cap Retaining Ring	1	•22	---	U-Cup Seal	1
4	See Chart 1	Air Cap & Retaining Ring	1	•23	---	Washer	1
5	See Chart 2	Fluid Tip	1	•24	---	Snap Ring	1
6	GTI-425	Baffle Assembly	1	25	JGS-449-1	Air Valve Assembly	1
•7	GTI-33-K5	Baffle Seal (Kit of 5)	1	26	P-MB-51	Air Inlet Nipple 1/4" NPS(M)	1
•8	JGA-4035-K5	Packing (Kit of 5)	1	27	---	Trigger Stud Screw	1
9	34411-122-K10	Packing Nut (Kit of 10)	1	28	---	Trigger Stud	1
10	GTI-405	Spreader Valve	1	29	JGS-478	Stud and Screw Kit	1
11	See Chart 2	Fluid Needle	1	30	---	Trigger	1
•12	JGS-72-K10	Gasket Kit (PTFE) (Kit of 10)	2	31	JGS-477-1	Trigger Stud, Screw Kit	1
13	---	Body Bushing	1	•32	---	Fluid Inlet Gasket (PTFE)	1
•14	---	Fluid Needle Spring	1	33	---	Locknut	1
•15	---	Spring Pad	1	34	---	Fluid Inlet Adapter	1
16	MBD-19-K10	Spring and Pad (Kit of 10)	1	35	JGA-4042	Fluid Inlet, Gasket, Nut Kit	1
17	GTI-414	Needle Adjusting Screw	1	•36	---	Retaining Clip	1
18	KK-5059	Bushing, Spring, Pad and Knob Kit	1	•37	---	Seal	1
•19	---	Air Valve Spring	1	•38	---	Pin	1
				39	GTI-428-K5	Clip, Seal & Pin Kit (5 each)	1
				40	---	Plug	1

• KK-5058-2 Gun Repair Kit includes a quantity of necessary parts.

## TROUBLESHOOTING

CONDITION	CAUSE	CORRECTION
<b>Heavy top or bottom pattern</b> 	Horn holes plugged. Obstruction on top or bottom of fluid tip. Cap and/or tip seat dirty.	Clean. Ream with non-metallic point. Clean. Clean.
<b>Heavy right or left side pattern</b> 	Left or right side horn holes plugged. Dirt on left or right side of fluid tip.  Remedies for the top-heavy, bottom-heavy, right-heavy, and left-heavy patterns: 1. Determine if the obstruction is on the air cap or the fluid tip. Do this by making a test spray pattern. Then, rotate the cap one-half turn and spray another pattern. If the defect is inverted, obstruction is on the air cap. Clean the air cap as previously instructed. 2. If the defect is not inverted, it is on the fluid tip. Check for a fine burr on the edge of the fluid tip. Remove with #600 wet or dry sand paper. 3. Check for dried paint just inside the opening; remove by washing with solvent.	Clean. Ream with non-metallic point. Clean.
<b>Heavy center pattern</b> 	Fluid flow too high for atomization air.  Material flow exceeds air cap's capacity. Spreader adjustment valve set too low. Atomizing pressure too low. Material too thick.	Balance air pressure and fluid flow. Increase spray pattern width with spreader adjustment valve. Thin or lower fluid flow. Adjust. Increase pressure. Thin to proper consistency.
<b>Split spray pattern</b> 	Atomization air pressure too high. Fluid flow too low.  Spreader adjusting valve set too high.	Reduce at transformer or gun. Increase fluid flow (increases gun handling speed). Adjust.
<b>Jerky or fluttering spray</b> 	*Loose or damaged fluid tip/seat. Baffle seal not installed correctly. Material level too low. Container tipped too far. Obstruction in fluid passage. Dry or loose fluid needle packing nut.	Tighten or replace. Install per directions. Refill. Hold more upright. Backflush with solvent. Lubricate or tighten.
<b>Unable to get round spray</b>	Spreader adjustment screw not seating properly. Air cap retaining ring loose.	Clean or replace.  Tighten.
<b>Will not spray</b>	No air pressure at gun.  Fluid needle adjusting screw not open enough. Fluid too heavy for suction feed.  Fluid pressure too low.	Check air supply and air lines, blow out gun air passages. Open fluid needle adjusting screw. Thin material and/or change to larger tip size, or pressure feed. Increase fluid pressure at tank.
<b>Starved spray pattern</b>	Inadequate material flow.  Low atomization air pressure.	Back fluid adjusting screw out to first thread, or change to larger tip size, or increase fluid pressure at tank. Increase air pressure and rebalance gun.
<b>Excessive overspray</b>	Too much atomization air pressure. Gun too far from work surface. Improper stroking (arcing, gun motion too fast).	Reduce pressure. Adjust to proper distance. Move at moderate pace, parallel to work surface.
<b>Excessive fog</b>	Too much or too fast-drying thinner. Too much atomization air pressure.	Remix properly. Reduce pressure.
<b>Dry spray</b>	Air pressure too high. Gun tip too far from work surface. Gun motion too fast. Gun out of adjustment.	Reduce air pressure. Adjust to proper distance. Slow down. Adjust.
<b>Fluid leaking from packing nut</b>	Packing nut loose. Packing worn or dry.	Tighten, do not bind needle. Replace or lubricate.
<b>Fluid leaking or dripping from front of gun</b>	Packing nut too tight. Dry packing. Fluid tip or needle worn or damaged. Foreign matter in tip. Fluid needle spring broken. Wrong size needle or tip.	Adjust. Lubricate. Replace tip and needle. Clean. Replace. Replace.
<b>Runs and sags</b>	Too much material flow. Material too thin. Gun tilted on an angle, or gun motion too slow.	Adjust gun or reduce fluid flow. Mix properly or apply light coats. Hold gun at right angle to work and adapt to proper gun technique.

\*Most common problem.

## TROUBLESHOOTING (continued)

CONDITION	CAUSE	CORRECTION
<b>Paint bubbles in cup</b>	Fluid tip not tight.	Tighten tip to 15-20 ft.-lbs.
<b>Thin, sandy coarse finish drying before it flows out</b>	Gun too far from surface. Too much air pressure.  Improper thinner being used.	Check distance. Normally approx. 6-8". Reduce air pressure and check spray pattern.  Follow paint manufacturer's mixing instructions.
<b>Thick, dimpled finish "orange peel"</b>	Gun too close to surface.  Air pressure too low. Improper thinner being used. Material not properly mixed. Surface rough, oily, dirty.	Check distance. Normally approx. 6-8". Too much material coarsely atomized. Increase air pressure or reduce fluid flow. Follow paint manufacturer's mixing instructions. Follow paint manufacturer's mixing instructions. Properly clean and prepare.



**ACCESSORIES**

**TGC-545 Aluminum Drip Free Suction Cups**

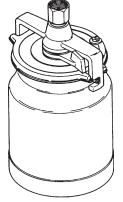

Cups have a unique, two position valve which permits selection of either a drip free or conventional open vent mode.

**192218 Scrubs® Hand Cleaner Towels**



Scrubs® are a pre-moistened hand cleaner towel for painters, body men and mechanics that go where you go and no water is needed.

**HARG-510 Air Regulator**

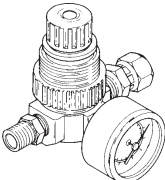

Use to maintain nearly constant outlet pressure despite changes in inlet pressure and downstream flow.

**HAV-500 OR HAV-511 Adjusting Valve (HAV-511 SHOWN)**



HAV-500 does not have pressure gage. Use to control air usage at gun.

**KK-5060 Air Cap Cleaning Kit**



Consists of: 2 brushes, 1 wire pick. Helps keep air cap clean and performing properly.

**HAF-507 Whirlwind™ In-Line Air Filter**



Removes water, oil, and debris from the air line.

**Automotive Quick Connects For HVLP Guns (Air) High Flow Type.**

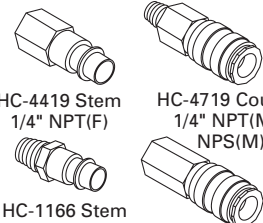

HC-4419 Stem 1/4" NPT(F)  
 HC-4719 Coupler 1/4" NPT(M) / NPS(M)  
 HC-1166 Stem 1/4" NPT(M)  
 HC-4720 Coupler 1/4" NPT(F)

**Spray Gun Lube SSL-10 (2 oz. bottle)**



Compatible with all paint materials; contains no silicone or petroleum distillates to contaminate paint. MSDS Sheet available upon request.

**GTI-415 Air Adjusting Valve**

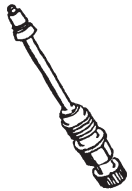

Installs into gun to enable user to control and reduce air usage at the gun. Replaces JGA-132 plug.

**JGA-156-K10 Spring Clips**



Joins any single piece DeVilbiss air cap with latest version MBC-368, MSA-1 or GTI-3 retaining rings. Helps prevent parts loss and provides easier assembly.

**WR-103 Wrench**

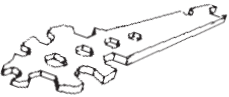

Contains all necessary tip, hose and nut sizes used on or with gun.

**192212 Professional Spray Gun Cleaning Kit**



Contains six precision tools designed to effectively clean all DeVilbiss, Binks, Finishline and other brand spray guns.

**Twin Cartridge, Paint Spray Respirator 40-128**



NIOSH-Certified (TC-84A-1623) for respiratory protection in atmospheres not immediately dangerous to life.

**WARRANTY**

This product is covered by DeVilbiss' 1 Year Limited Warranty.

---

**DeVilbiss Sales and Service: [www.devilbiss.com](http://www.devilbiss.com)**

---

**DeVilbiss Automotive Refinishing**

DeVilbiss has authorized distributors throughout the world. For equipment, parts and service, check the Yellow Pages under "Automotive Body Shop Equipment and Supplies." For technical assistance, see listing below.

**U.S.A./Canada Customer Service Office:**

11360 S. Airfield Road, Swanton, OH 43558  
Toll-Free Telephone: 1-800-445-3988 (U.S.A. and Canada only)  
Toll-Free Fax: 1-800-445-6643

**DEVILBISS**  
AUTOMOTIVE REFINISHING