

TSC-595 STAINLESS STEEL DRIP FREE SUCTION CUP

Important: Before using this equipment, read all safety precautions and instructions. Retain for future use.

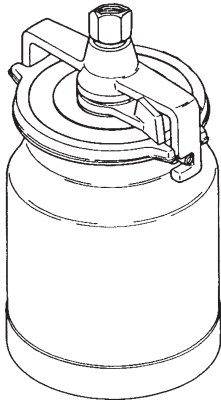

Figure 1

Product is covered by U.S.A. Patent Nos. 287.994, 4,760,753

DESCRIPTION

Model: TSC-595
Thread Size: 3/4" NPS
Weight: 20 ounces

The TSC-595 stainless steel, 1 quart capacity cup has a unique, two position valve which permits selection of either a drip free spraying mode or a conventional open vent mode.

The stainless steel cup is designed for use with corrosive type materials, such as waterbornes. This cup is also suitable for use with finishes containing halogenated hydrocarbon solvents.

In the drip free position, air is directed through the vent in the lid to a channel beneath the gasket before entering the cup at the valve. This allows the cup to be tilted when full without dripping paint through the vent. The cup can also be inverted momentarily while spraying without leaking.

The open position isolates the channel and opens a direct vent into the cup.

The position of the valve is indicated by alignment of the hole in the valve slot with the marks cast on the lid. These positions are identified as "O" for vent open and "D/F" for Drip Free.

INSTALLATION

1. Position yoke at right angle to gun body with vent hole in lid toward rear and lever of cam (3) toward front of gun.
2. Fasten cup lid assembly to gun by attaching nut (2), see Figure 4, to fluid inlet nipple on gun. Tighten nut with wrench.
3. Strain material to be sprayed through a 60-90 mesh screen before pouring into cup.
4. Engage pins on cup into yoke and tighten yoke by moving lever of cam clockwise.

OPERATION

Open Vent Mode "O" - To operate in the open vent mode, rotate the valve with a screwdriver or coin so that the hole in the valve slot is aligned with the "O" on the lid. See Figure 2.

If the valve slot hole should plug while operating in the "O" vent mode, use a pointed tool such as a nail or drill bit to probe through the valve slot hole to clear away the obstruction.

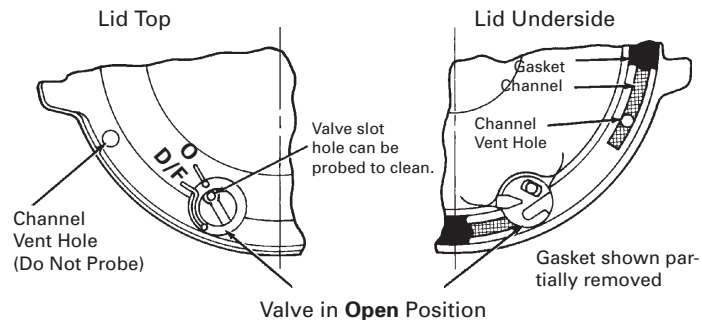

Figure 2 - Open Vent Mode

Drip Free Mode "D/F" - To operate in the drip free mode, rotate the valve with a screwdriver or coin so that the hole in the valve slot is aligned with the "D/F" on the lid. See Figure 3.

CAUTION

Do not probe through the channel vent hole at any time. Do not probe through the valve slot hole while the valve is in the "D/F" position. These holes are sealed by a gasket and gasket damage could result. See Figures 2 and 3.

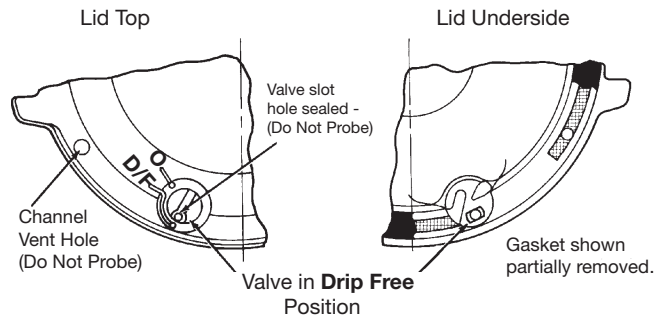

Figure 3 - Drip Free Model

Valve Movement - Do not forcibly rotate the valve. If it will not move freely, soak in solvent or remove the lid assembly from the cup and press down on the top of the valve until it breaks free. The valve has free travel vertically of about 1/8". This can be used to push out the gasket.

SAFETY PRECAUTIONS

This manual contains important information that ALL users should know and understand BEFORE using the equipment. This information relates to USER SAFETY and PREVENTING EQUIPMENT PROBLEMS. To help you recognize this information, we use the following terms to draw your attention to certain equipment labels and portions of this manual. Pay special attention to any label or information that is highlighted by one of these terms:



Important information to alert you to a situation that might cause injury or loss of life.





Important information that tells how to prevent damage to equipment

Note

Information that you should pay special attention to.

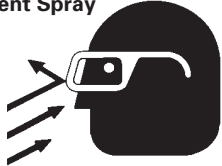

The following hazards may occur during the normal use of this equipment. Please read the following chart.

HAZARD	CAUSE	SAFEGUARDS
Fire 	Solvents and coatings can be highly flammable or combustible, especially when sprayed.	Do not spray near open flames, pilot lights in stoves or heaters, or other heat sources. Adequate ventilation must always be provided. Industrial applications must comply with OSHA requirements.
Solvent Spray 	During cleaning and flushing, solvents can be forcefully expelled from fluid and air passages. Some solvents can cause eye injury or irritation.	Wear eye protection.
Explosion Hazard - Incompatible Materials 	Chlorinated solvents, such as 1, 1, 1 - Trichloroethane and Methylene Chloride (sometimes called methyl chloride) can chemically react with aluminum used in many spray system components to produce an explosion hazard.	<ol style="list-style-type: none"> 1. Read the label or data sheet for the material you intend to spray. 2. Do not use any type of coating material containing these solvents with components containing aluminum. 3. Do not use these solvents for equipment cleaning or flushing. 4. If in doubt as to whether a material is compatible, contact your material supplier.
Inhaling Toxic Substances 	Certain materials may be harmful if inhaled, or if there is contact with the skin.	Follow the requirements of the Material Safety Data Sheet supplied by your coating material manufacturer. Adequate exhaust must be provided to keep the air free of accumulations of toxic materials. Use a mask or respirator whenever there is a chance of inhaling sprayed materials. The mask must be compatible with the material being sprayed and its concentration. Equipment must be as prescribed by an industrial hygienist or safety expert, and be NIOSH approved.

MAINTENANCE**Lid Repair/Replacement:**

1. To replace a damaged part, use a 5/16 inch Allen wrench to loosen and remove adapter (1). The nut (2), yoke, cam (3) or lid and tube assembly are now loose for replacement.
2. Replace damaged parts. The cam lever should be located on opposite side of lid from valve (4).
3. Apply sealant (Loctite #262) to the first two full threads of adapter (1). Insert threaded end of adapter into open end of nut (2).
4. Install adapter (1) and nut (2) in top of lid and tube assembly. Use a 5/16" Allen wrench to tighten firmly (10-12 foot pounds).

Valve and Lid Gasket Replacement:

1. To remove a damaged valve (4) or lid gasket (5), press on top of valve until it breaks free. The valve pushes the lid gasket from the seat. The lid gasket may now be removed from the lid. Continue pressing hard on the valve to remove it from the lid.
2. Install replacement valve (4) through bottom of lid so that the valve tab is toward center of lid. Snap in place. If necessary, use a plastic mallet or screwdriver handle to tap the valve in place. Press the lid gasket firmly in the lid using the end of a crescent wrench. Insert the side with the black marks first.

CLEANING

General: For routine cleaning, it is not necessary to remove the lid gasket. It is not necessary or desirable to remove the valve for any cleaning procedure. The valve can be depressed from the outside to assist in removal of the gasket for gasket replacement or when cleaning dried paint from the channel. The valve should not be forced past the shoulder which retains it in the lid except for replacement.

Note

The cam and mating surfaces on the lid and yoke normally don't require removal for cleaning. Spraying some materials containing PTFE or similar materials can necessitate more frequent cleaning and possible disassembly of the cam. The overspray containing PTFE can build up on the cam and mating surfaces causing a condition where the cam may loosen during use.

Air Pressure: Always clean with reduced air pressure. An air pressure no greater than 15 to 20 psi will allow quick and thorough cleaning of the cup and gun and at the same time will:

1. Minimize the amount of solvent atomized into the air.
2. Prevent possibility of damage to cup from excessive back pressure.
3. Reduce the force with which solvent is expelled from the vent.

Cleaning Procedures:

1. Empty paint from cup and add small amount of clean solvent. The amount required will vary with different coatings and solvents.
2. Shake cup to wash down inside surfaces. Then spray solvent at low air pressure (15-20 psi) to flush out fluid passages.
3. Pour out solvent and add same amount of clean solvent.
- 4a. Again, shake cup. Loosen air cap. Hold a folded cloth over front of gun and invert cup over solvent receptacle. Trigger with short bursts to back flush vent channel. With valve in **D/F** position, solvent will be expelled with force from the channel vent hole in lid.

Alternative to Step 4a.

- 4b. Shut off air to gun. With valve in **D/F** position, invert cup over solvent receptacle. Trigger gun. Allow solvent to drip out channel vent hole in lid for several seconds, or until clean solvent is seen.
5. Clean cam and mating surface on lid with a solvent soaked Scotch™ pad and blow dry. If cam loosening persists, removal of the yoke and cam will be required for more thorough cleaning of these parts. Again, use a solvent soaked Scotch™ pad for this purpose. Reassemble lid.



• Do not probe through the channel vent hole at any time. Do not probe through the valve slot hole while the valve is in the D/F position. These holes are sealed by gasket (5) and gasket damage could occur.

• Cup assembly may also be cleaned with a gun washer. Follow directions of gun washer manufacturer.

IMMERSION

Since all materials in the cup are highly solvent resistant, the cup assembly may be immersed for cleaning. Immersion should not exceed 24 hours. The use of paint strippers should be avoided because strippers will affect the aluminum as well as other non-metallic components. If the lid gasket has become swollen from prolonged exposure to solvents, it will return to its original size without loss of properties when allowed to dry.

Parts List

Ref. No.	Replacement Part No.	Description	Ind. Parts Req.
1*	---	Adapter, 1/2" NPS (M)	1
2*	---	Nut, 3/8" NPS (F)	1
3*	---	Cam	1
4*	TGC-407-1-K3	Drip Free Valve and Gasket (Kit of 3)	1
5*	TGC-9-K5	**Tri Seal® Lid Gasket (Kit of 5)	1
6	TSC-407	Lid Assembly	1
7	TSC-400	Cup Assembly (Stainless Steel Quart)	1

*KK-5008 Repair Kit includes Ref. Nos. 1-5. Repair kit contains enough parts to repair one complete assembly.

Suffix -K3 designates a kit of multiple parts.
Example: TGC-407-1-K3 is a kit of 3 drip free valves.

** Registered Trademark of Tri-Seal International.

WARRANTY

This product is covered by De'Vilbiss' 1 Year Limited Warranty. See SB-1-000 which is available upon request.

Figure 4

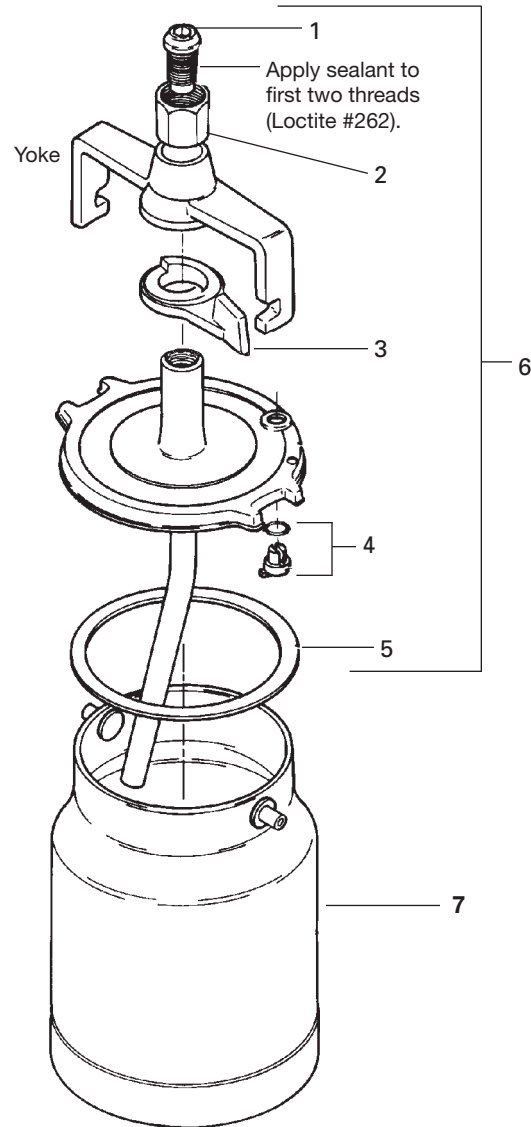

WARRANTY

This product is covered by De'Vilbiss' 1 Year Limited Warranty.

De'Vilbiss Sales and Service: www.devilbiss.com



U.S.A./Canada Customer Service
195 Internationale Blvd.
Glendale Heights, IL 60139
630-237-5000

Toll Free Customer Service
and Technical Support
800-992-4657
Toll Free Fax
888-246-5732