

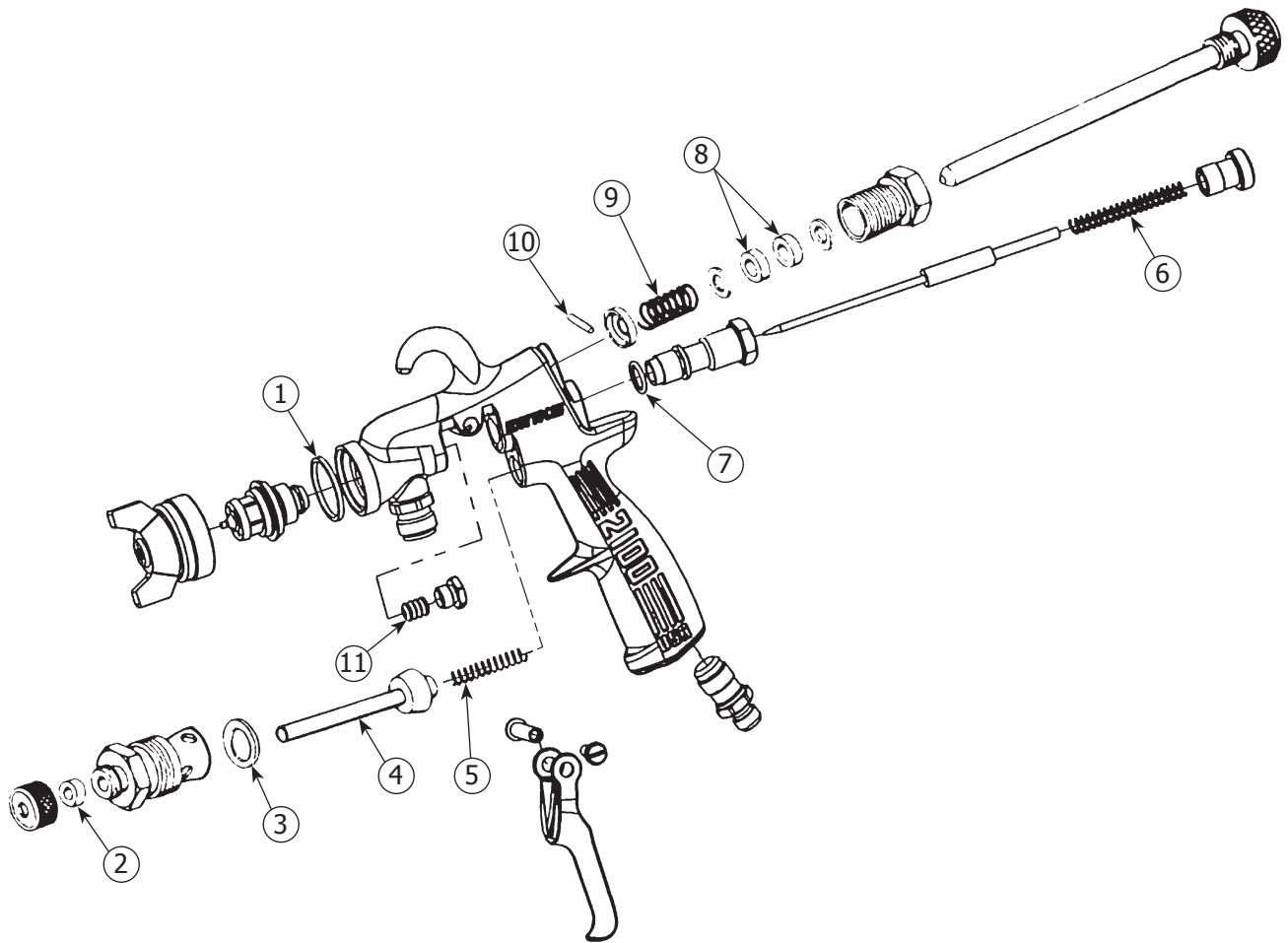

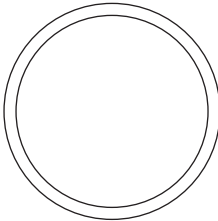





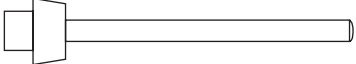

**BINKS® 6-229 REPAIR KIT FOR 2100, 2101,  
2001, 2001SS AND 2001V SPRAY GUNS**



## PARTS LIST

Parts shown at actual size.

ITEM NO.	DESCRIPTION	
1	Gasket, Fluid Nozzle	
2	Packing, Valve Stem	
3	O-Ring, Air Valve	
4	Valve Stem, Air Valve	
5	Spring, Air Valve	
6	Spring, Needle	
7	O-Ring, Body	
8	Packings (2), Side Port	
9	Spring, Side Port	
10	Pin, Side Port	
11	Packing, Needle – PTFE	

---

**NOTES**

---

## WARRANTY POLICY

This product is covered by Carlisle Fluid Technologies' materials and workmanship limited warranty. The use of any parts or accessories, from a source other than Carlisle Fluid Technologies, will void all warranties. Failure to reasonably follow any maintenance guidance provided may invalidate any warranty.

For specific warranty information please contact Carlisle Fluid Technologies.

Carlisle Fluid Technologies is a global leader in innovative finishing technologies. Carlisle Fluid Technologies reserves the right to modify equipment specifications without prior notice.

DeVilbiss®, Ransburg®, ms®, BGK®, and Binks®  
are registered trademarks of Carlisle Fluid Technologies, Inc.

©2019 Carlisle Fluid Technologies, Inc.  
All rights reserved.

---

For technical assistance or to locate an authorized distributor,  
contact one of our international sales and customer support locations.

<b>Region</b>	<b>Industrial / Automotive</b>	<b>Automotive Refinishing</b>
Americas	Tel: 1-800-992-4657 Fax: 1-888-246-5732	Tel: 1-800-445-3988 Fax: 1-800-445-6643
Europe, Africa, Middle East, India	Tel: +44 (0)1202 571 111 Fax: +44 (0)1202 573 488	
China	Tel: +8621-3373 0108 Fax: +8621-3373 0308	
Japan	Tel: +81 45 785 6421 Fax: +81 45 785 6517	
Australia	Tel: +61 (0) 2 8525 7555 Fax: +61 (0) 2 8525 7575	

For the latest information about our products, visit [www.carlisleleft.com](http://www.carlisleleft.com)